

Kardelen Kitchen Mixer

KAS®

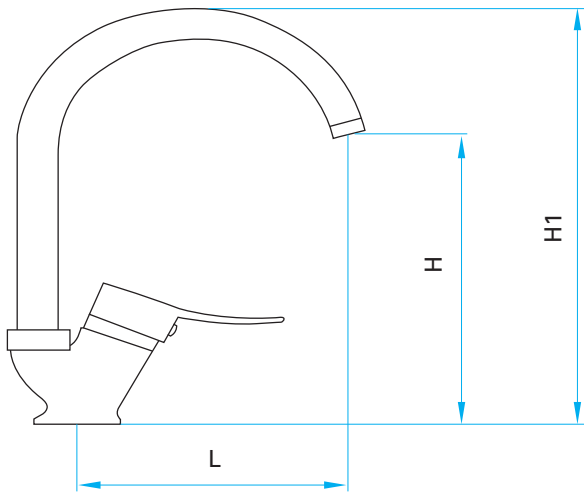

Standard	TS EN 817
Usage Temperature	-5 °C / +65 °C
Usage Area	Water Installation
Flow Pressure	Min. 1 bar / Max. 5 bar
Static (Installation) Pressure	10 bar

Usage area : Suitable for hot and cold water usage in kitchen and multi functional offices

Specifications:

- Easy to use with ergonomic design.
- Aerator with descaling system
- 12 lt. water flow per minute
- Mixes the flowing water with air with a versatile aerator and creates a softer feeling.
- Provides usage without splashing with versatile aerator.
- Easy installation
- 100% leak test during production.
- Brightness and easy cleaning with KAS mixer polish.

Dimension	PRODUCT CODE - 9231704		
	H	H1	L
	240 mm	330 mm	170 mm



Installation and Using Instructions:

- 1- The mixer pipe is fixed to the housing nipple and the pipe nut is tightened to the housing.
- 2- Place the base O-ring under the mixer.
- 3- Flexes are screwed to the base of the mixer.
- 4- The stud is screwed into the body.
- 5- Place the mixer on the sink
- 6- Flex hoses are connected to the bottom of the body.
- 7- The half moon seal and the sheet metal are threaded and the stud nut is tightened until the body is fixed.
- 8- Connect the flex hoses to the hot and cold taps.
- 9- Use a pressure regulator if the pressure of the system is above 6 bar.

PRODUCT SPECIFICATIONS	
Body	Brass (CW617N) TS EN 12165
Body Tube	Brass (CW617N) TS EN 12165
Arm	Zamak
Cartridge	Ceramic / ABS
Aerator Pipe	Brass (CW617N) TS EN 12165
Double Perforated Half Moon	Sac
Press Nut	PA6 GF30
Funnel	ABS
Body Connection Nipple	Brass (CW617N) TS EN 12165
M8 Pivot Nut	Brass (CW617N) TS EN 12165
M8 Nut	Brass (CW617N) TS EN 12165

SURFACE SPECIFICATIONS (COVERING)	
Body	Nickel / Chrome (5-10 µm)
Body Tube	Nickel / Chrome (5-10 µm)
Arm	Nickel / Chrome (5-10 µm)
Aerator Pipe	Nickel / Chrome (5-10 µm)
Funnel	Nickel / Chrome (5-10 µm)
Double Perforated Half Moon	Nickel / Chrome (5-10 µm)
M8 Pivot Nut	Nickel / Chrome (5-10 µm)
M8 Nut	Nickel / Chrome (5-10 µm)



* In case of defect or failure of the product, you can return it with the invoice and guarantee certificate and get the new one free of charge from our factory.

** Do not forget to get the **Warranty Certificate** and the invoice from your dealer with this product. Warranty Certificate is valid with the invoice.

Please read the warranty rules.